



1T-MV-8474 4K Multiviewer

User Guide V1.6

Firmware versions 3.0.0.C CL885 and above
MNL-1T-MV-8474 V1.6
July 2016

In this guide

Features.....	1
In the box	1
Safety precautions.....	2
Quick start.....	3
Front panel.....	5
Rear panel.....	6
IR remote control	7
External controls	8
The web interface	8
IP connections.....	8
Network settings.....	8
RS-232	9
Audio channels.....	10
On-screen display.....	11
Enabling and disabling the OSD	11
Installing the 4K Multiviewer.....	12
Wiring Diagram.....	12
Operation	13
Starting up and shutting down the 4K Multiviewer	13
Window layouts.....	13
Configuring your display	16
Example display configurations.....	17
Changing the resolution of your output.....	21
Audio settings.....	22
Locking the front panel.....	25
Advanced operation	26
Saving power with automatic shutdown	26

Restoring the default factory settings	26
Changing the baud rate	27
Switching the analog input between RGB and YPbPr.....	27
Turning auto-adjust on and off for VGA sources	28
Firmware.....	28
Copying, uploading and downloading EDID	29
Specifications	31
Limited warranty	37
Regulatory compliance.....	38
Liability statement	39
Contact us	40

Thanks for buying this 1T-MV-8474 4K Multiviewer from tvONE.

The 4K Multiviewer allows you to display up to four video sources on the same screen, in crisp 4K detail. You can display both digital and analog video from a wide range of devices, and play everything from mono to 7.1 surround-sound audio. Control is quick and simple, whether you're using the built-in buttons, the remote control, or the fully featured web interface.

Features

Inputs include four HDMI, two DisplayPort and one RGB/YPbPr

HDMI and DisplayPort source input with 4K x 2K @30 Hz

MHL for the four HDMI inputs

HDMI output resolutions, including 4K x 2K @30 Hz and 1080p

Auto-scaler for each source input

Auto-detects EDID

16 multi-window modes

Up to four simultaneous videos

HDCP compliant

Fast switch between input ports

7.1 analog and digital audio

Multi-channel HDMI, DisplayPort audio de-embedding, optical TOSLINK and eight-channel analog outputs

Easy-to-use panel and web interface

Multiple control methods, including an assignable front panel, IR remote control, LAN and RS232 port

LAN includes web interface, Telnet and UDP

1 RU high, 19" wide standard enclosure, rack mountable

In the box

1T-MV-8474 4K Multiviewer

Remote control

AC power cord

2 rack mounting brackets

User guide

MNL-1T-MV-8474 V1.6

Safety precautions

Read all instructions before attempting to unpack, install or operate this equipment, and before connecting the power supply.



Risk of injury from fire or electric shock

- Follow basic safety precautions.
- Do not expose this product to rain or moisture.
- Do not install this product near water.
- Do not spill liquid onto or into this product.



Risk of damage to equipment

- Do not push an object of any kind into this product through any openings or empty slots.
- Use only the supplied AC power cord. Do not use the power cord if it is damaged.
- Do not block any vents or openings in the unit housing that provide ventilation. Allow sufficient space for air to circulate around the unit.

Quick start

It's easy to get started with the 4K Multiviewer, but there's more help later on, if you need it.

1. Connect your video and audio sources to the input ports, and your display to an output port.

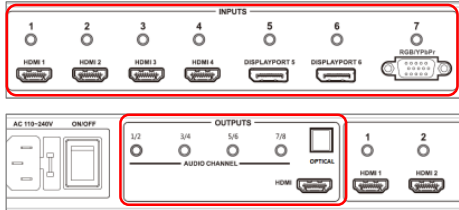

2. Connect the AC power cord, and then connect the plug to an electrical outlet. Switch on.

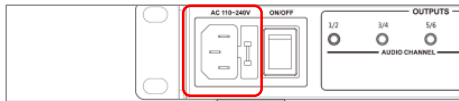

3. Switch on.

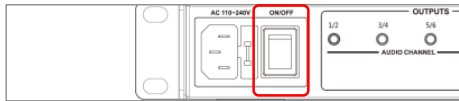

4. Press a button to choose a window layout.

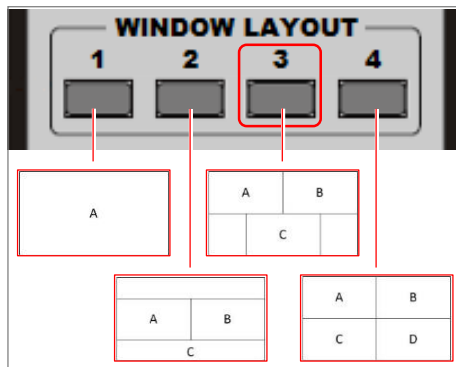

5. Choose which source you want to appear in which window. Press a button in the WINDOW SELECT area, then press a button in the INPUT SELECT area.

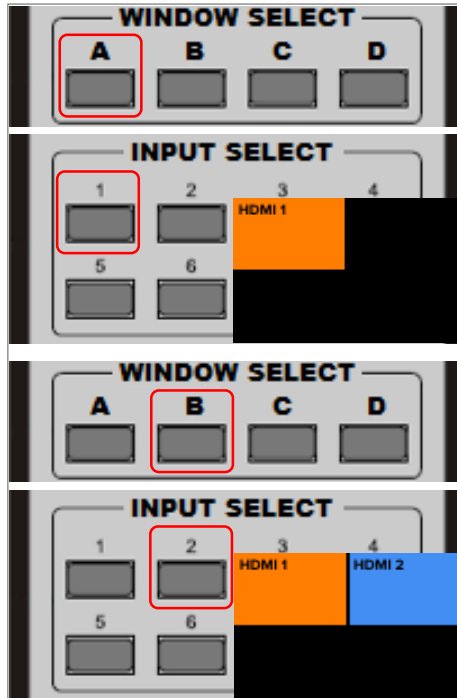

6. Choose where you want your sound to come from. Press the AUDIO button, then press a button in the INPUT SELECT area.

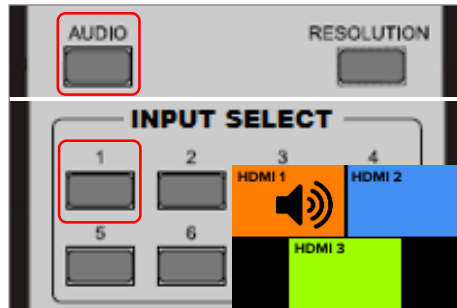

Front panel



INPUT SELECT	Buttons 1 to 7 correspond with video or audio inputs. The input buttons light up to indicate the status of the video or audio input.
AUDIO SELECT	Press to select the audio input required. The currently selected input button lights up, and the others flash. Press an input select button to choose a new audio input.
WINDOW SELECT	Buttons A to D represent the four possible windows. When you press a window select button, the associated input button lights up, and the others flash.
WINDOW LAYOUT	Buttons 1 to 4 allow you to select pre-programmed window layout modes. The default modes are single window, double window, triple window and quadruple window. You can associate other layouts with these buttons with the web interface.
OUTPUT RESOLUTION	Press the SELECT button to change the resolution. A light indicates the current output.
POWER	Indicates when the unit has power.
STANDBY	Switches between standby and working mode. The button lights up during standby.

Rear panel



AC 110-240V	Connect the AC power cord provided to an available electrical outlet.
AUDIO CHANNEL	8-channel analog audio output. Connect a 3.5 mm stereo input to the line-in jack of a multimedia system.
OPTICAL	Connect the optical output port to the digital audio input port of your amplifier.
HDMI	Connect an HDMI cable from this port to an HD (1080p or 720p) or 4K display.
INPUTS 1-7	7 2-channel stereo analog audio inputs. Connect a 3.5 mm stereo input from the line-out jack on the audio source to one of these jacks.
HDMI 1-4	Connect up to four sources to these inputs using HDMI cables.
DISPLAYPORT 5/6	Connect up to two sources to these inputs using DisplayPort cables.
RGB/YPbPr	Connect a hi-definition source to this input using DB-15 cable or YPbPr-VGA cable.
USB	USB port for firmware updates.
LAN	Connect to a LAN source with an Ethernet cable to use IP control.
RS232	Connect an RS-232 device to this port with an RS-232 cable.

IR remote control

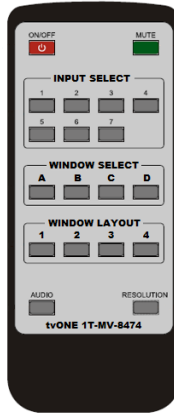

INPUT SELECT	Press buttons 1 to 7 to select the corresponding video input or audio input.
WINDOW SELECT	Buttons A to D represent the four possible windows. When you press a window select button, the associated input button lights up, and the others flash.
WINDOW LAYOUT	Buttons 1 to 4 allow you to select pre-programmed window layout modes. The default modes are single window, double window, triple window and quadruple window. You can associate other layouts with these buttons with the web interface.
AUDIO	Press to select the audio input required. The currently selected input button lights up, and the others flash. Press an input select button to choose a new audio input.
MUTE	Turn the sound on and off.
RESOLUTION	Press to change the resolution. A light in the OUTPUT RESOLUTION area on the front panel of the 4K Multiviewer indicates which resolution is currently selected.

External controls

The web interface

You can control the 4K Multiviewer from any modern browser with the web interface. You can do any of the tasks that you would otherwise do using the front panel or remote control, plus some more advanced tasks.

Finding out the IP address of your 4K Multiviewer

The 4K Multiviewer automatically uses DHCP to get an IP address when it is connected to a valid network.

You can see the IP address on the on-screen display (OSD). To display the IP address, press any button in the WINDOW LAYOUT area.

If the OSD has been disabled and you need to know the IP address, then you must reset the 4K Multiviewer to its factory default settings.

If your network doesn't support DHCP, or you connect directly to the 4K Multiviewer, use the factory default IP address 10.0.0.10.

Opening the web interface

- To open the web interface, open any browser and enter the IP address for the 4K Multiviewer.

For more information about the OSD, see page 8.

For instructions on resetting the 4K Multiviewer to its factory default settings, see page 26.

IP connections

The 4K Multiviewer supports Telnet, UDP and TCP/IP.

Network settings

On the **Network** tab of the web interface, you can adjust your network settings.

Configuring your network address

You can enable and disable DHCP and change your IP address, Subnet Mask, Gateway and DNS.

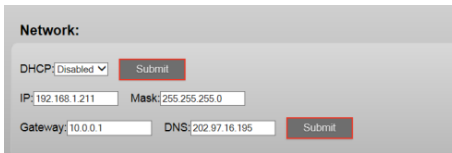

Note: If you change your network address, your 4K Multiviewer and your computer can end up with different address ranges. You might need to modify the network address of your computer to connect to the 4K Multiviewer.

Configuring sockets

You can choose from TCP Server, TCP Client, TCP Auto, UDP Mode or UDP Multicast.

- Choose an option from the Socket drop-down list and select Submit.

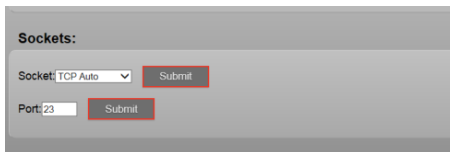

- Enter a port number and select Submit. The default port number is 23.

RS-232

The RS-232 port

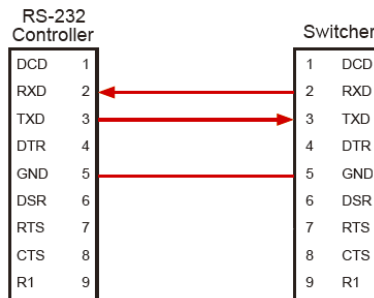
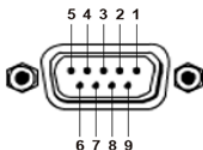

Connect the RS-232 to RXD, TXD and GND only.

RS-232 Settings

Baud rate	9600
Data bits	8
Parity	None
Stop bits	1
Hardware flow control	None

For more information about serial command lines, see the separate API document for the 1T-MV-8474 4K Multiviewer.

You can download the API document from the **Support Information** tab at <http://www.tvone.com/4k-multiviewer>.

Audio channels

There are three methods of audio output:

- HDMI output
- Optical output (TOSLINK)
- Analog output, 8 channels

If the analog input audio format is only 2 channels (Stereo), it uses channels 1 and 2 of the analog outputs. If the input format is 5.1 it uses channels from 1 to 6 to output the audio. If the input format is 7.1 it uses channels from 1 to 8 to output the audio.

Note: Optical output (TOSLINK) only supports stereo.

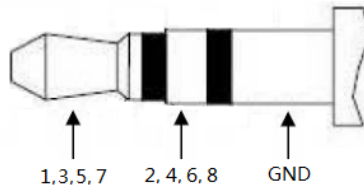
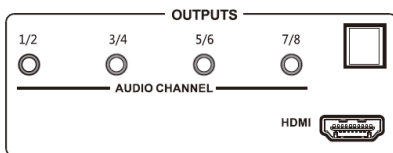

Audio Format	Channel							
	1	2	3	4	5	6	7	8
2.0	L	R						
2.1	L	R	LFE					
5.1	FL	FR	LFE	FC	RL	RR		
7.1	FL	FR	LFE	FC	RL	RR	RLC	RRC

On-screen display

The on-screen display (OSD) shows video, audio and the IP address of the 4K Multiviewer.

By default, the OSD is set to on. The OSD displays the status and resolution of the source for each window. If nothing is connected, the OSD displays **XX not connected**. XX is the input port: HDMI 1-4, DISPLAYPORT 5-6 or RGB/YPbPr.

Enabling and disabling the OSD

You can enable or disable the OSD on the **Advanced** tab of the web interface.

- To turn information about audio on or off, choose an option from the **Audio OSD** drop-down list.
- To turn information about video on or off, choose an option from the **Video OSD** drop-down list.

The screenshot shows two rows of settings on a grey background. The first row is labeled 'Audio OSD' and has a dropdown menu set to 'On' and a red 'Submit' button. The second row is labeled 'Video OSD' and also has a dropdown menu set to 'On' and a red 'Submit' button.

Installing the 4K Multiviewer

1. Connect up to four 4K or HD HDMI sources to input ports HDMI 1 to HDMI 4.
2. Connect up to two 4K or HD DisplayPort sources to input ports DISPLAYPORT 5 and DISPLAYPORT 6.
3. Connect one VGA or YPbPr source to input port RGB/YPbPr.
4. Connect output port HDMI to one UHD 4K or HD display.
5. OPTIONAL – you can also connect any of the following inputs and outputs.
 - Connect up to seven stereo analog audio sources to audio input ports INPUT 1 to 7.
 - Connect the 3.5 mm stereo outputs to up to four 2-channel inputs of an audio receiver, or connect the OPTICAL port to the optical input of an audio receiver.
 - Connect an RS-232 serial controller to the RS-232 port.
 - Connect a Local Area Network (LAN) to the LAN port.
6. Connect the AC power cord to the 4K Multiviewer, and connect the plug to an available electrical outlet.

Wiring Diagram

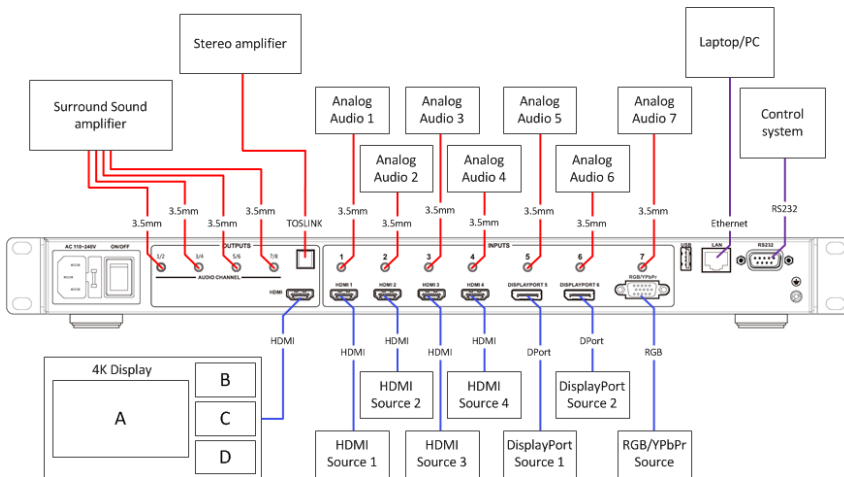

Operation

Starting up and shutting down the 4K Multiviewer

The POWER light on the front panel lights up red to indicate the unit has power. If the indicator does not light up, check the power cord is plugged in correctly and that the power switch on the rear panel is turned on.

When the unit is in standby mode, the STANDBY button lights up green. In normal working mode the STANDBY button is not lit.

1. Switch the ON/OFF switch on the rear panel to **I** (on).
2. To start up or shut down the 4K Multiviewer, choose one of the following options.
 - Press the STANDBY button on the front panel
 - Press the ON/OFF button on the remote control
 - Use a command from a device connected by Ethernet or RS-232 cable
 - Use the **Advanced** tab of the web interface

You can save power by allowing the 4K Multiviewer to shut down automatically when there are no active inputs.

For more information about shutting down automatically, see page 26.

Window layouts

Overview of window layouts

The 4K Multiviewer can display up to four video sources on your HDMI output device. Each source is displayed in a window. Each combination of windows and positions is a window layout.

The 4K Multiviewer offers up to 16 window layouts. On the front panel or the remote control, you can choose from four predefined layouts. You can choose any of the 16 layouts and configure which four layouts are available on the front panel and remote control using the web interface.

The 16 window layouts

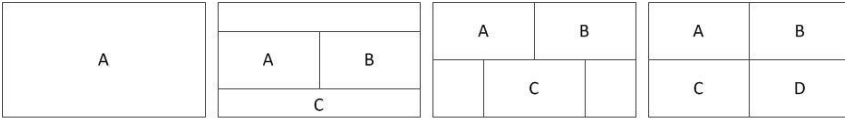

Default layouts corresponding to buttons 1 to 4 on the front panel and remote control

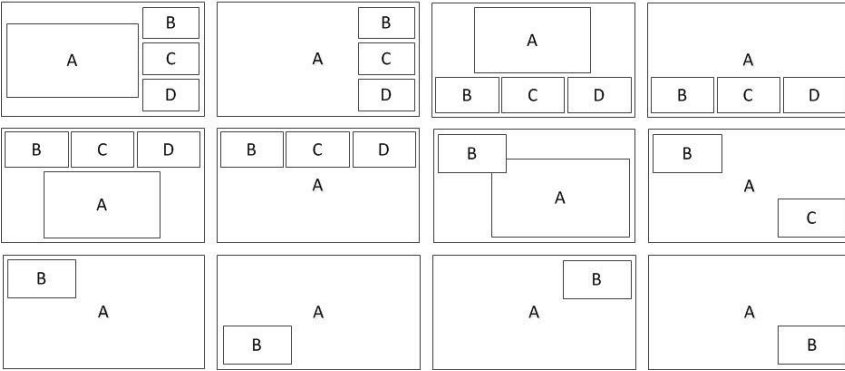

You can choose any four layouts as your default layouts.

Note: the layouts you see may differ slightly depending on the version of your firmware. The layouts shown here are from firmware versions 3.0.1.1 CL1051 and above.

Choosing a window layout from your default options

- On the remote control or the front panel, press one of the four buttons from the WINDOW LAYOUT area.

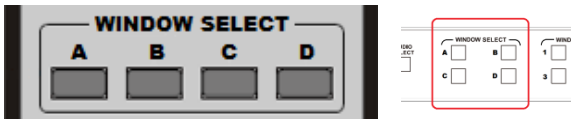

The screen connected to the HDMI output port shows the window layout, and the button stays lit.

In the WINDOW SELECT area of the front panel, buttons light up to show which windows belong to your chosen window layout.

In the INPUT SELECT area of the front panel, buttons light up to indicate the currently selected sources.

Choosing a window layout with the web interface

1. On the **General** tab, select a window layout.

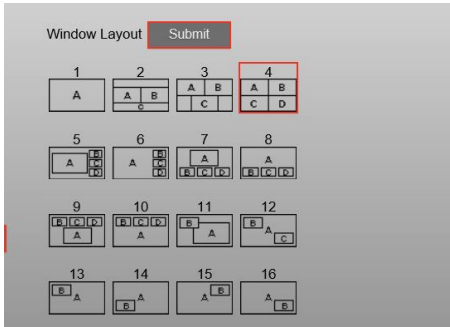

2. Select **Submit**.

Choosing your own default window layouts

You can assign any of the 16 window layouts to a button in the WINDOW LAYOUT area on the front panel and remote control. Choose your defaults on the **General** tab.

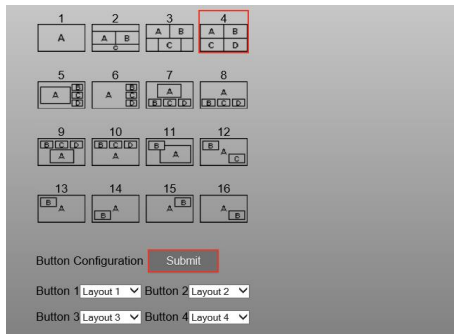

1. For each button, choose a window layout from the drop-down list.
2. Select **Submit**.

Tip: Make a note of which window layout is associated with which button.

Configuring your display

Use the front panel, remote control or web interface to choose any window layout, and then choose which video source appears in which window. You can show the same source in multiple windows.

Configuring displays

1. To select a window layout, press a button in the WINDOW LAYOUT area.

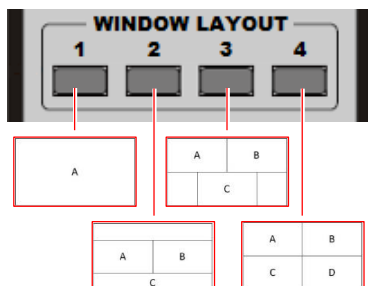

In the WINDOW SELECT area of the front panel, buttons light up to show which windows belong to your chosen window layout.

In the INPUT SELECT area of the front panel, buttons light up to indicate the currently selected sources.



2. To select which source you want to appear in which window, press a button in the WINDOW SELECT area, then press a button in the INPUT SELECT area.

Repeat this step for each window of your chosen display.

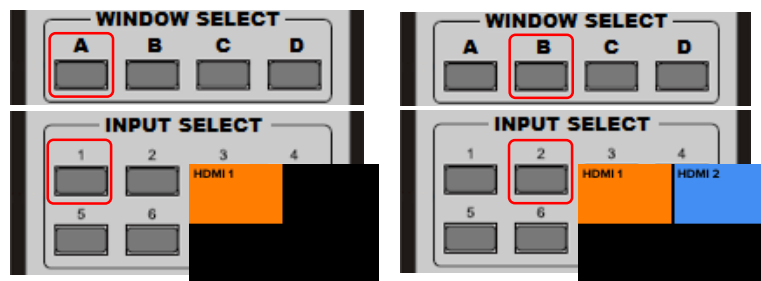

Example display configurations

Key to example configurations

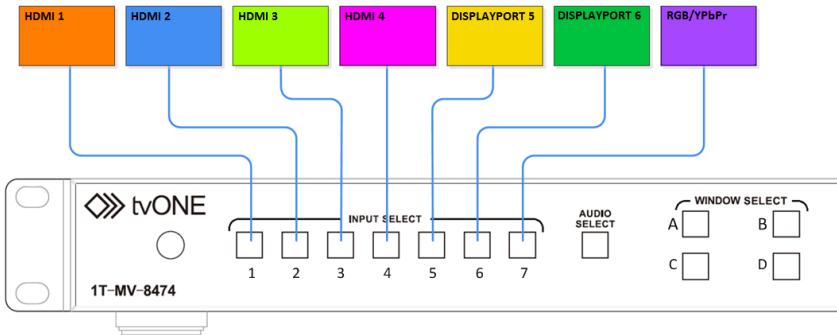
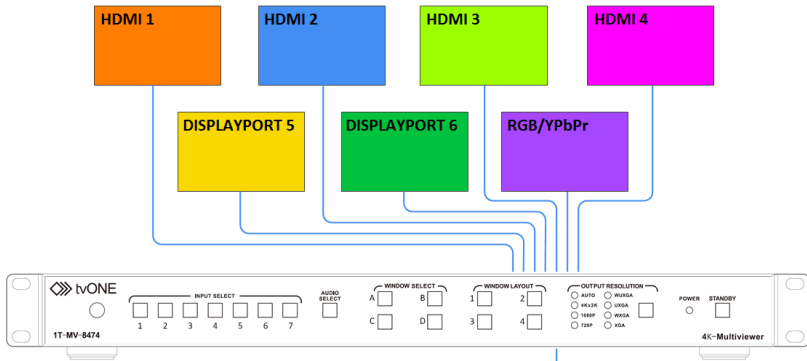

Example of a single window display

This display shows one input source, in window A. To configure the example below, press A, 5.



Example of a double window display

This display shows two input sources in windows A and B.

Note: firmware versions 3.0.1.1 CL1051 and above include a third window, the background. Window C has no source allocated to it by default, but you can choose one if you want to.

To configure the example below, press:

- A, 5
- B, 6

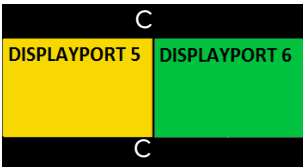

Example of a triple window display

This display shows three input sources in windows A, B and C.

To configure the example below, press:

- A, 1
- B, 2
- C, 3



Example of a quadruple window display

This display shows four input sources in windows A, B, C and D.

To configure the example below, press:

- A, 1
- B, 2
- C, 3
- D, 7



Configuring window layouts in the web interface

You can configure any of the window layouts on the **General** tab of the web interface.

1. For each window in your chosen window layout, choose an input from the drop-down list.

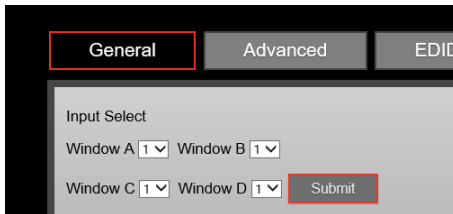

2. Select **Submit**.

Turning off a window to leave it blank

Note: this feature is only available for firmware version 3.0.1.1 CL1051 or above.

You can turn off a window to leave it blank/black on the **Advanced** tab of the web interface and on the front panel.

Source Remove(On: Source Enable Off: Source Disable)

Layout 1: Win A on ▾ Submit

Layout 2: Win A on ▾ Win B on ▾ Win C on ▾ Submit

Layout 3: Win A on ▾ Win B on ▾ Win C on ▾ Submit

Layout 4: Win A on ▾ Win B on ▾ Win C on ▾ Win D on ▾ Submit

Layout 5: Win A on ▾ Win B on ▾ Win C on ▾ Win D on ▾ Submit

Layout 6: Win A on ▾ Win B on ▾ Win C on ▾ Win D on ▾ Submit

Layout 7: Win A on ▾ Win B on ▾ Win C on ▾ Win D on ▾ Submit

Layout 8: Win A on ▾ Win B on ▾ Win C on ▾ Win D on ▾ Submit

Layout 9: Win A on ▾ Win B on ▾ Win C on ▾ Win D on ▾ Submit

Layout 10: Win A on ▾ Win B on ▾ Win C on ▾ Win D on ▾ Submit

Layout 11: Win A on ▾ Win B on ▾ Submit

To turn off a window on the front panel:

1. In the WINDOW SELECT area, press and hold button A, B, C or D for five seconds.
The window turns black. If the on-screen display is turned on, a label indicates the source has been removed.
2. To turn the window back on, press and hold the same button for five seconds.

Changing the aspect ratio of a window

You can change the aspect ratio of any window on the **General** tab of the web interface.

1. For each window, choose an aspect ratio from the drop-down list.

Aspect Ratio

Window A Normal ▾ Window B Normal ▾

Window C Normal ▾ Window D Normal ▾ Submit

The options for aspect ratio are:

- Normal – use the original aspect ratio from the input source
- Full – fill the window
- 16:9
- 4.3

2. Select **Submit**.

Automatically positioning VGA/RGB

You can choose to automatically position VGA/RGB sources. Activate or deactivate auto-positioning on the **Advanced** tab of the web interface.

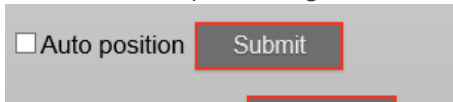

The screenshot shows a grey rectangular control panel. On the left, there is a checkbox labeled "Auto position". To its right is a red-bordered button labeled "Submit".

Note: Auto-positioning isn't available for YPbPr.

Changing the resolution of your output

To change the resolution of your output, press the **SELECT** button in the **OUTPUT RESOLUTION** area of the front panel repeatedly until the LED for the resolution you want is lit.

You can also change the output resolution on the **General** tab of the web interface.



The screenshot shows a grey rectangular control panel. On the left, there is a dropdown menu labeled "Output Resolution" with "AUTO" selected. To its right is a red-bordered button labeled "Submit".

Read about which resolutions the 4K Multiviewer supports on page 35.

Audio settings

Connecting a backup analog audio input

Each digital input can provide video and audio. You can connect an analog audio source to act as a backup for each source. If the digital input has no audio, the 4K Multiviewer automatically switches to the backup audio source.

- Connect the backup audio source to the 3.5 mm jack that corresponds to the digital source.
For example, to provide backup audio for the source connected to the HDMI 1 port, connect a device to jack 1.

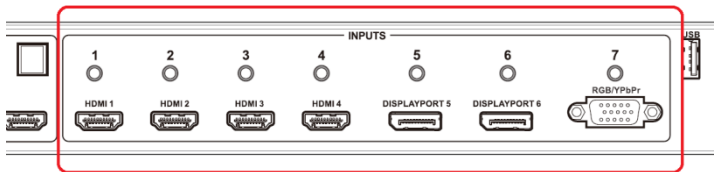

You can also choose to always use the backup analog source.

Choosing to always use an analog audio source

For each input, you can choose to always use the audio from an analog source, or to only use the analog source as a backup.

Configure how the 4K Multiviewer plays audio on the **General** tab of the web interface.

- To always use an analog source for an input, for that input, select **External** from the drop-down list.
- To only use an analog source as a backup for an input, select **Auto** from the drop-down list.

Audio Input Configuration:

1	Auto	2	Auto	3	Auto
4	Auto	5	Auto	6	Auto

Submit

Note: VGA/RGB/YPbPr does not include an audio signal. If you use the VGA input, connect an analog audio input.

Selecting an audio source

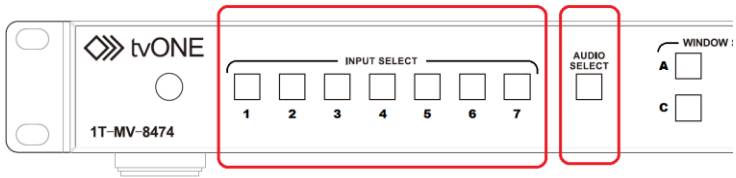

1. Press the AUDIO SELECT button.
In the INPUT SELECT area, the button for the currently selected audio input lights up and the other buttons flash.
If you don't change the audio source within five seconds, the buttons stop flashing.
2. To change the audio source, in the INPUT SELECT area, press the button for that source.
After five seconds the audio changes to the new source.
3. To change the audio source using the web interface, on the **General** tab, choose an option from the **Audio Input** drop-down list and select **Submit**.



Syncing audio with audio delay

You can delay your audio source to synchronize with your video sources. Choose to delay audio up to 400 ms on the **Advanced** tab of the web interface.

Setting	Delay in milliseconds
0	0
1	40
2	80
3	120
4	160
5	200
6	240
7	280
8	320
9	360
10	400

- To delay audio, enter a number from 1-10 in the **Audio Delay** field and select **Submit**.
- To stop delaying audio, enter 0 in the in the **Audio Delay** field and select **Submit**.

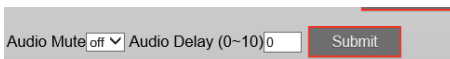

Audio Mute: off | Audio Delay (0-10): 0 | Submit

Locking the front panel

There are two ways to lock the 4K Multiviewer, the admin lock and the complete lock.

- When the admin lock is active, the STANDBY and OUTPUT RESOLUTION buttons are locked.
- When the complete lock is active, all the buttons are locked.

To activate or deactivate the admin lock

You can activate or deactivate the admin lock on the **Advanced** tab of the web interface, and you can deactivate the admin lock on the front panel.



- To activate the admin lock in the web interface, select the **Admin** option from the **Front Panel Lock** drop-down list.
- To deactivate the admin lock in the web interface, select the **Unlock** option.
- To deactivate the admin lock on the front panel, in the WINDOW SELECT area, press and hold buttons A and D until the standby button flashes once.
If the front panel does not unlock, repeat this step.

To activate or deactivate the complete lock

You can activate or deactivate the complete lock on the **Advanced** tab of the web interface, or on the front panel.



- To activate the complete lock in the web interface, select the **Complete** option from the **Front Panel Lock** drop-down list.
- To deactivate the complete lock in the web interface, select the **Unlock** option.
- To activate or deactivate the complete lock on the front panel, in the WINDOW SELECT area, press and hold buttons A and D until the standby button flashes once.

Advanced operation

Saving power with automatic shutdown

On the **Advanced** tab of the web interface you can tell the 4K Multiviewer to automatically go into standby mode after a set amount of time.

Automatic shutdown only happens when there are no signals from the active sources. When the signals stop, the 4K Multiviewer starts the auto timer and enters standby mode when the time has run out. When the 4K Multiviewer receives a signal, it starts up again.

- To enable automatic shutdown, enter a time from 1-60 minutes in the **Power Saving** field and select **Submit**.
- To disable automatic shutdown, enter 0 in the **Power Saving** field and select **Submit**.

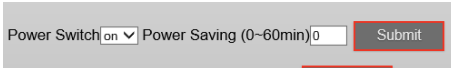

A screenshot of a web interface showing a 'Power Switch' dropdown menu set to 'on', a 'Power Saving (0-60min)' input field containing the number '0', and a 'Submit' button. A red box highlights the 'Submit' button.

Restoring the default factory settings

You can restore the factory settings on the **Advanced** tab of the web interface, or on the front panel.



A screenshot of a web interface showing a 'Restore to default' checkbox and a 'Submit' button. A red box highlights the 'Submit' button.

To restore the factory settings on the front panel:

1. Press the **STANDBY** button.
The 4K Multiviewer enters standby mode.
2. In the **INPUT SELECT** area, press and hold button 5.
3. Press the **STANDBY** button.
The 4K Multiviewer enters active mode.
All buttons and lights on the front panel flash to indicate the unit is being set to factory default.
The 4K Multiviewer reboots and the OSD shows the window status, IP address and port number.

When you restore the factory default settings, the IP address of the 4K Multiviewer is reset.

Read about how to find the new IP address on page 8.

Restoring default network settings

You can restore your default network settings on the **Network** tab.

- Select the **Revert network setting to factory default settings** check box and select **Submit**.

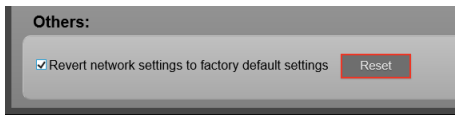

Note: This action resets the IP address to the factory default IP address 10.0.0.10. You might not be able to connect to the web interface until the IP address range of your computer and the 4K Multiviewer are in the same range.

Read more about the IP address of the 4K Multiviewer on page 8.

Changing the baud rate

You can choose a baud rate from 9600, 14400, 19200, 28800, 38400, 57600, 115200. We recommend that you use 9600.

Change the baud rate on the **Advanced** tab of the web interface.



Switching the analog input between RGB and YPbPr

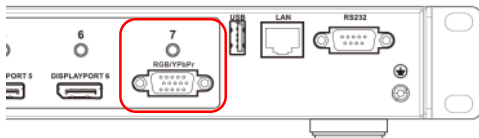

You can switch the VGA input between RGB and YPbPr on the **Advanced** tab of the web interface.

1. Select either RGB or YPbPr from the Analog setting drop-down list.
2. Select **Submit**.



3. Reboot the 4K Multiviewer.

For instructions on rebooting the 4K Multiviewer, see page 13.

Turning auto-adjust on and off for VGA sources

When auto-positioning is active, the OSD displays **Auto Adjust** in the window assigned to the VGA source.

You can activate or deactivate auto-positioning on the **Advanced** tab of the web interface.

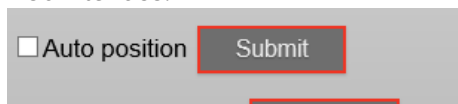

Firmware

Finding your firmware version

To find out what version of firmware you are using, see the **Advanced** tab of the web interface.

Updating firmware

You can update the 4K Multiviewer with a USB drive.

Risk of damage to equipment: Do not switch off the 4K Multiviewer until the upgrade process is completed, or the firmware will be corrupted.

Note: the USB port can only support up to 500 mA.

1. Download the latest firmware from www.tvone.com/firmware-updates.
Search for 1T-MV8474.
2. Copy the file called **MERGE.bin** to the root directory of a USB drive.
3. With the 4K Multiviewer switched off, connect the USB drive to the USB port on the rear of the device.
4. Connect an HDMI display to the HDMI OUTPUT port.
5. Switch on the 4K Multiviewer.
6. When the 4K Multiviewer is in active mode, in the INPUT SELECT area, press and hold button 1 for more than five seconds.
7. The output screen shows **System is upgrading...** and all buttons and lights on the front panel flash.
When the update is complete, the output screen shows **Upgrading is successful, system will reboot.**
After a few seconds, the 4K Multiviewer reboots.

- When the 4K Multiviewer has finished rebooting, switch it off and then back on.

It may be necessary to update the web interface as part of the firmware upgrade process. Contact tvONE Technical Support for assistance.

For contact details, see the back page of this guide.

Copying, uploading and downloading EDID

On the **EDID** tab of the web interface you can copy the Extended Display Identification Data (EDID) from an output device to any input device. You can also download the EDID to your computer, or upload an EDID from your computer.

What is EDID?

EDID is a data structure provided by a digital display to describe its capabilities to a video source, for example, a graphics card or set-top box.

Normally the device displaying the output sends EDID to the device supplying the source. Occasionally, if there is a device between the input and output devices, the information isn't received correctly and the picture becomes offset or distorted.

Troubleshooting offset or distorted video

If the video in one or more windows is offset or distorted, first try copying the EDID to that input device.

Copying an EDID to an input device

- For each affected input, select your output device from the drop-down list, and select **Submit**.

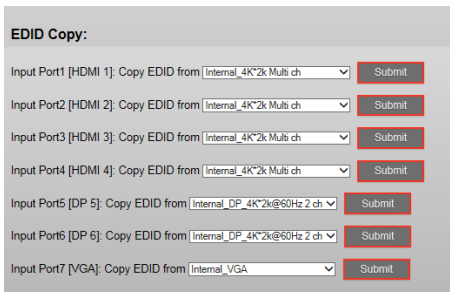

The screenshot shows a web interface titled "EDID Copy:". It contains a list of seven input devices, each with a dropdown menu for selecting an output device and a "Submit" button. The input devices and their current output selections are:

Input Device	Output Device Selection
Input Port1 [HDMI 1]: Copy EDID from	Internal_4K*2k Multi ch
Input Port2 [HDMI 2]: Copy EDID from	Internal_4K*2k Multi ch
Input Port3 [HDMI 3]: Copy EDID from	Internal_4K*2k Multi ch
Input Port4 [HDMI 4]: Copy EDID from	Internal_4K*2k Multi ch
Input Port5 [DP 5]: Copy EDID from	Internal_DP_4K*2k@60Hz 2 ch
Input Port6 [DP 6]: Copy EDID from	Internal_DP_4K*2k@60Hz 2 ch
Input Port7 [VGA]: Copy EDID from	Internal_VGA

Uploading a different EDID

If copying the EDID doesn't work, try uploading an EDID that you know does work, for example, from a display device that you know works well with that specific input device.

There are seven custom slots available on the 4K Multiviewer for storing EDID files in .bin format. Each slot can contain only one EDID file.

- Browse to the EDID file on your computer.

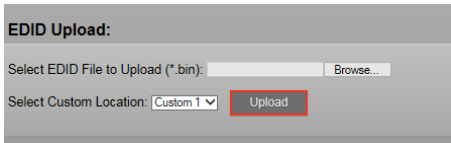

The screenshot shows the 'EDID Upload' dialog box. It has a title bar 'EDID Upload:'. Below the title bar, there is a text input field labeled 'Select EDID File to Upload (*.bin):' followed by a 'Browse...' button. Below that, there is a dropdown menu labeled 'Select Custom Location:' with 'Custom 1' selected, and an 'Upload' button.

- Select a slot from the **Select Custom Location** drop-down list.
- Select **Upload**.

Downloading and editing an EDID

You can also download an EDID, edit the EDID, and upload it again.

- Right-click an option and select **Save Target as ...** to save an output, an input, or an EDID stored in a custom slot on the 4K Multiviewer.

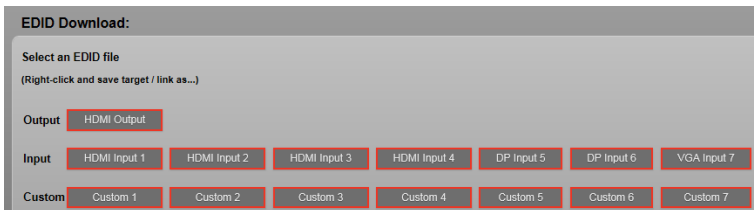

The screenshot shows the 'EDID Download' dialog box. It has a title bar 'EDID Download:'. Below the title bar, there is a section 'Select an EDID file' with the instruction '(Right-click and save target / link as...)'. There are three rows of buttons: 'Output' with 'HDMI Output', 'Input' with 'HDMI Input 1', 'HDMI Input 2', 'HDMI Input 3', 'HDMI Input 4', 'DP Input 5', 'DP Input 6', and 'VGA Input 7', and 'Custom' with 'Custom 1', 'Custom 2', 'Custom 3', 'Custom 4', 'Custom 5', 'Custom 6', and 'Custom 7'.

- Edit the EDID.
- Upload the edited EDID to a new custom slot on the 4K Multiviewer.

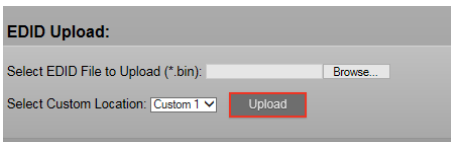

The screenshot shows the 'EDID Upload' dialog box. It has a title bar 'EDID Upload:'. Below the title bar, there is a text input field labeled 'Select EDID File to Upload (*.bin):' followed by a 'Browse...' button. Below that, there is a dropdown menu labeled 'Select Custom Location:' with 'Custom 1' selected, and an 'Upload' button.

Specifications

Functionality

Video input formats	<ul style="list-style-type: none">• HDMI• DVI• DisplayPort• RGBHV• YPrPb
Audio input formats	<ul style="list-style-type: none">• HDMI and DisplayPort: embedded digital• External analog stereo audio: 20 kΩ impedance
Video output formats	<ul style="list-style-type: none">• HDMI
Audio output formats	<ul style="list-style-type: none">• HDMI: embedded digital audio• 7.1 surround analog audio: 20 kΩ impedance• TOSLINK: digital optical audio
Format compliance	<ul style="list-style-type: none">• HDMI v1.4• DVI v1.0• DisplayPort v1.2• HDCP v1.4
Color depth	<ul style="list-style-type: none">• 8-bit• 10-bit• 12-bit
EDID memory	<ul style="list-style-type: none">• Advanced EDID utilities
Audio bandwidth	<ul style="list-style-type: none">• 20 Hz to 20 kHz
Audio sampling rate	<ul style="list-style-type: none">• 48 kHz
Channels	<ul style="list-style-type: none">• 8CH
Format	<ul style="list-style-type: none">• LPCM
Audio levels	<ul style="list-style-type: none">• Stereo audio: unity / nominal• Stereo audio: 0.5-1.0 V_{P-P}

Audio delay	<ul style="list-style-type: none">• User-adjustable from 0-400 ms in increments of 40 ms
-------------	--

Inputs

Video	<ul style="list-style-type: none">• 6 digital• 1 analog RGB
-------	--

Audio	<ul style="list-style-type: none">• 6 digital• 7 stereo analog
-------	---

Outputs

Video	<ul style="list-style-type: none">• 1 HDMI/DVI
-------	--

Audio	<ul style="list-style-type: none">• 1 digital optical, embedded HDMI• 4 stereo (analog 7.1)
-------	--

Input connectors

HDMI/DVI	<ul style="list-style-type: none">• 4 HDMI 19-pin female connectors
----------	---

DisplayPort	<ul style="list-style-type: none">• 2 20-pin female locking connectors
-------------	--

Analog RGB	<ul style="list-style-type: none">• 1 HD15 (VGA) female connector
------------	---

Analog Audio	<ul style="list-style-type: none">• 7 stereo 3.5mm female connectors
--------------	--

Power	<ul style="list-style-type: none">• 1 IEC C14 power connector
-------	---

Output connectors

HDMI/DVI	<ul style="list-style-type: none">• 1 HDMI 19-pin female connector
----------	--

Digital audio	<ul style="list-style-type: none">• 1 TOSLINK Optical female connector
---------------	--

Analog audio	<ul style="list-style-type: none">• 4 3.5mm female connectors
--------------	---

Control

Configuration	<ul style="list-style-type: none">• Web interface• RS-232• Ethernet• IR remote control• front panel buttons
Application	<ul style="list-style-type: none">• Web interface
Buttons	<ul style="list-style-type: none">• 7.5 mm square colored LED backlit

Dimensions

Without feet or rack mounting brackets (H x W x D)	<ul style="list-style-type: none">• 44 x 439 x 279 mm (1.7 x 17.3 x 11.0 inches)
With feet (H)	<ul style="list-style-type: none">• 51 mm (2.0")
With rack mounting brackets (W)	<ul style="list-style-type: none">• 483 mm (19.0")
Weight	<ul style="list-style-type: none">• 3.3 kg (7.3 lb)

Power

AC power	<ul style="list-style-type: none">• 100-240 V AC / 50-60 Hz
Power consumption	<ul style="list-style-type: none">• 15 W maximum

Materials

Front panel	<ul style="list-style-type: none">• 10mm aluminum alloy with black finish
Chassis	<ul style="list-style-type: none">• 1mm pressed steel with matte black finish

Environmental

Operating temperature	<ul style="list-style-type: none">• 0 °C to 40 °C (32 °F to 104 °F)
Storage temperature	<ul style="list-style-type: none">• -20 °C to 60 °C (-4 °F to 14 °F)
Operating humidity	<ul style="list-style-type: none">• 20% to 90% non-condensing
Product item number	<ul style="list-style-type: none">• 1T-MV-8474 4K Multiviewer

Accessories

Included	<ul style="list-style-type: none">• 19 Button remote control• AC power cable• User Guide• 2x rack mounting brackets
----------	--

Warranty

Limited warranty	<ul style="list-style-type: none">• 3-year warranty for parts and labor
------------------	---

Regulatory compliance

Main unit	<ul style="list-style-type: none">• FCC• CE• RoHS
-----------	---

Input Resolution

Resolution	P/I	HDMI	DisplayPort	VGA
640 x 350	P	85		
640 x 400	P	85		85
640 x 480	I	30		
640 x 480	P	60/75/85		75/85
720 x 400	P	85		
720 x 480	I			60

Resolution	P/I	HDMI	DisplayPort	VGA
720 x 576	I	25		50
720 x 576	P	50/100		
800 x 600	P	60/75/85	60	60
848 x 480	P			60
1024 x 768	P	60/75/85		60/70/75
1152 x 864	P			75
1280 x 720	P	50/60	60	50/60
1280 x 768	P	60/75/85		60/75/80
1280 x 960	P	60/85		
1280 x 1024	P	60/75/85		60/75
1366 x 768	P			60
1600 x 900	P		60	
1600 x 1024	P	60		
1600 x 1200	P	60		60/65/70/75
1680 x 1050	P			60
1792 x 1344	P			60
1856 x 1392	P			60
1920 x 1080	I	25/30		50/60
1920 x 1080	P	24/25/30/ 50/60	60	24/25/30/ 60
1920 x 1200	P	60		60
1920 x 1440	P			60
2048 x 1152	P		60	
3840 x 2160	P	24/30	30/60	

HDMI output resolution

AUTO	The output resolution is selected automatically based on information read from the display device.
4Kx2K	3840 x 2160 @30 Hz
1080P	1920 x 1080 @ 60 Hz
720P	1280 x 720 @ 60 Hz
WUXGA	1900 x 1200 @ 60 Hz
UXGA	1600 x 1200 @ 60 Hz
WXGA	1280 x 800 @ 60 Hz
XGA	1024 x 768 @ 60 Hz

Limited warranty

tvONE warrants the original purchaser that the equipment it manufactures or sells will be free from defects in materials and workmanship for a fixed term from the date of purchase. The warranty term for specific product lines is defined below.

1. tvONE branded products based on tvONE's CORIO technology are warranted for a period of five years from the date of purchase. This includes products with the model number prefix of C2, 1T-C2, CX, A2 or S2.
2. tvONE products, other than those based on tvONE's CORIO technology mentioned above, are warranted for a period of three years from the date of purchase. This includes products with the model number prefix of 1T, with the exception of 1T-C2.
3. LCD Monitors are warranted for a period of three years from the date of purchase, with the exception of the LCD panels integrated into the monitors that are supplied by third parties. LCD panels are limited to the term and conditions of the warranty offered by the respective LCD panel manufacturer. Such specific LCD panel warranties are available upon request to tvONE.

Should a product, in tvONE's opinion, prove defective within this warranty period, tvONE, at its discretion, will repair or replace this product without charge. Any defective parts replaced become the property of tvONE. This warranty does not apply to those products which have been damaged due to accident, unauthorized alterations, improper repair, modifications, inadequate maintenance and care, or use in any manner for which the product was not originally intended.

If repairs are necessary under this warranty policy, the original purchaser must obtain a Return Authorization Number from tvONE and return the product to a location designated by tvONE, freight prepaid. After repairs are complete, the product will be returned, freight prepaid.

LIMITATIONS - All products sold are "as is" and the above Limited Warranty is in lieu of all other warranties for this product, expressed or implied, and is strictly limited to the stated number of years from the date of purchase. tvONE assumes no liability to distributors, resellers or end-users or any third parties for any loss of use, revenue or profit.

tvONE makes no other representation of warranty as to fitness for the purpose or merchantability or otherwise in respect of any of the products sold. The liability of tvONE with respect to any defective products will be limited to the repair or replacement of such products. In no event shall tvONE be responsible or liable for any damage arising from the use of such defective products whether such damages be direct, indirect, consequential or otherwise, and whether such damages are incurred by the reseller, end-user or any third party.

Regulatory compliance

The 1T-MV-8474 has been tested for compliance with appropriate FCC and CE rules and regulations. The power adaptor/supply has been tested for compliance with appropriate UL and CUL rules, regulations and/or guidelines. This product and power adapter are RoHS compliant.

Liability statement

This product is intended for professional use. This product is not intended for use in a medical environment and does not have the required certifications for such use. Similarly, use aboard any aircraft or spacecraft while in flight or as an adjunct to any surface, airborne or marine navigation system or any offshore marine activity, including control of any watercraft, or any use similar to those specifically herein mentioned is prohibited. Use in the aforementioned circumstances would require additional testing and certification.

No warranty is made either expressed or implied including but not limited to any implied warranties of merchantability or fitness for a particular purpose. In no event shall the supplier or manufacturer of this product be liable for errors found within, or be liable for any direct, indirect or consequential damages or loss in connection with the purchase or use of this hardware, software or manual. The sole and exclusive liability to the supplier and manufacturer regardless of the form of action shall not exceed the replacement cost of the materials described herein.

tvONE reserves the right to revise any of its hardware and software products following its policy to modify and/or improve its products where necessary or desirable. This statement does not affect the legal rights of the user in any way.

By using this equipment, you have indicated that you have agreed to the terms listed above. If you do not wish to agree or the above terms are contrary to your conditions of purchase you may return the equipment, unused, to your supplier.

All third party trademarks and copyrights are recognized. The tvONE logo, Magenta logo, CORIO word and the CORIO logo are registered trademarks of tvONE. All other trademarks are the property of their respective holders.

E&OE

Contact us

www.tvone.com

info@tvone.com

tvONE NCSA

North, Central and South America

 2791 Circleport Drive, Erlanger,
KY 41018, USA

 Tel +1 859-282-7303
Fax +1 859-282-8225

 Sales: sales@tvone.com
Support: tech.usa@tvone.com

tvONE EMEA

Europe, Middle East, Africa and Asia
Pacific

 Continental Approach, Westwood
Industrial Estate, Margate, Kent,
CT9 4JG, UK

 Tel +44 (0)1843 873311
Fax +44 (0)1843 873312

 Sales: sales.europe@tvone.com
Support: tech.europe@tvone.com

Copyright 2016 tvONE. All rights reserved.

Information in this document is subject to change without notice. The software described in this document is furnished under a license agreement or nondisclosure agreement. The software may be used or copied only in accordance with the terms of those agreements. No part of this publication may be reproduced, stored in a retrieval system, or transmitted in any form or any means electronic or mechanical, including photocopying and recording for any purpose other than the purchaser's personal use without the written permission of tvONE.